

SOCCER TABLE

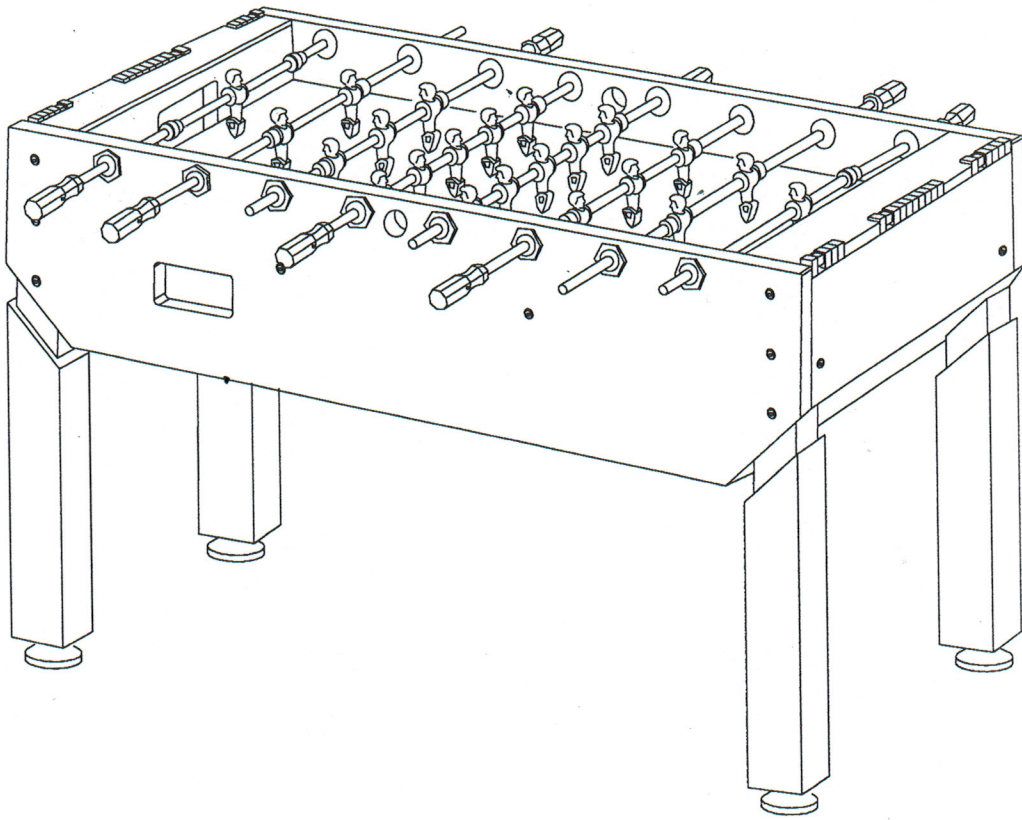

• Assembly/Instructions/Rules •







Congratulations! We hope you will enjoy many hours of play on your new Foosball Table!

Please Carefully read all safety instructions and directions before proceeding.

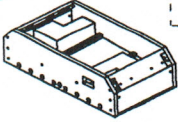
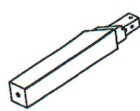
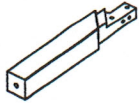
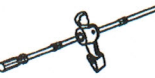
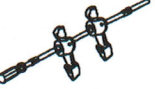
- 1) Your table is designed for use indoors in a climate controlled environment only. Damage can occur if the table is exposed to water, dampness, high humidity, freezing temperatures, etc.
- 2) The foosball table is heavy. Two or more people are required for assembly.
- 3) Only use the table for its intended purpose.
- 4) Damaged or worn parts may be dangerous for users and the integrity of the table. Replace worn or damaged components immediately and do not use the table until any issues have been resolved. For best results, use only spare parts available through supplier.
- 5) Unauthorized repairs or altering the table's design or functions may be dangerous and will void the warranty.
- 6) Check all screws, bolts, etc. on a regular basis to ensure that they are in good working condition and have not loosened over time.
- 7) Please keep the balls, lubricant and other parts out of reach of children and pets.
- 8) This is not a toy. Adult supervision is recommended when being used by children.
- 9) Please use care when pushing or pulling the rods so people or objects nearby do not get injured or damaged.

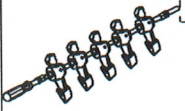
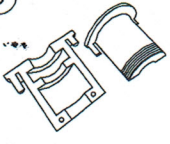
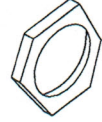
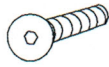

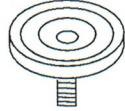

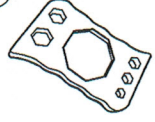

PARTS LIST

(Add a Check (✓) to the box to indicate receipt of each part.)

	<table border="1"> <tr><td>TABLE BODY</td></tr> <tr><td>1438*756*350 mm</td></tr> <tr><td>1 PC</td></tr> </table>	TABLE BODY	1438*756*350 mm	1 PC		<table border="1"> <tr><td>LEGS-LEFT</td></tr> <tr><td>730*100*100mm</td></tr> <tr><td>2 PCS</td></tr> </table>	LEGS-LEFT	730*100*100mm	2 PCS		<table border="1"> <tr><td>LEGS-RIGHT</td></tr> <tr><td>730*100*100mm</td></tr> <tr><td>2 PCS</td></tr> </table>	LEGS-RIGHT	730*100*100mm	2 PCS
TABLE BODY														
1438*756*350 mm														
1 PC														
LEGS-LEFT														
730*100*100mm														
2 PCS														
LEGS-RIGHT														
730*100*100mm														
2 PCS														
	<table border="1"> <tr><td>GOALIE ROD</td></tr> <tr><td>1086mm</td></tr> <tr><td>2 PCS</td></tr> </table>	GOALIE ROD	1086mm	2 PCS		<table border="1"> <tr><td>2PLAYERS ROD</td></tr> <tr><td>1254mm</td></tr> <tr><td>2 PCS</td></tr> </table>	2PLAYERS ROD	1254mm	2 PCS		<table border="1"> <tr><td>3PLAYERS ROD</td></tr> <tr><td>1124mm</td></tr> <tr><td>2 PCS</td></tr> </table>	3PLAYERS ROD	1124mm	2 PCS
GOALIE ROD														
1086mm														
2 PCS														
2PLAYERS ROD														
1254mm														
2 PCS														
3PLAYERS ROD														
1124mm														
2 PCS														
	<table border="1"> <tr><td>5PLAYERS ROD</td></tr> <tr><td>1010mm</td></tr> <tr><td>2 PCS</td></tr> </table>	5PLAYERS ROD	1010mm	2 PCS		<table border="1"> <tr><td>BEARINGS</td></tr> <tr><td>∅57*48.5mm</td></tr> <tr><td>8 PCS</td></tr> </table>	BEARINGS	∅57*48.5mm	8 PCS		<table border="1"> <tr><td>ASSEMBLED TO ⑧</td></tr> <tr><td>57*6mm</td></tr> <tr><td>8 PCS</td></tr> </table>	ASSEMBLED TO ⑧	57*6mm	8 PCS
5PLAYERS ROD														
1010mm														
2 PCS														
BEARINGS														
∅57*48.5mm														
8 PCS														
ASSEMBLED TO ⑧														
57*6mm														
8 PCS														
	<table border="1"> <tr><td>BOLTS</td></tr> <tr><td>M8*85mm</td></tr> <tr><td>16 PCS</td></tr> </table>	BOLTS	M8*85mm	16 PCS		<table border="1"> <tr><td>WASHERS</td></tr> <tr><td>M8</td></tr> <tr><td>4 PCS</td></tr> </table>	WASHERS	M8	4 PCS		<table border="1"> <tr><td>LEG LEVELERS</td></tr> <tr><td>∅90*50mm</td></tr> <tr><td>4 PCS</td></tr> </table>	LEG LEVELERS	∅90*50mm	4 PCS
BOLTS														
M8*85mm														
16 PCS														
WASHERS														
M8														
4 PCS														
LEG LEVELERS														
∅90*50mm														
4 PCS														
	<table border="1"> <tr><td>TOOLS</td></tr> <tr><td>5 mm</td></tr> <tr><td>2PCS</td></tr> </table>	TOOLS	5 mm	2PCS		<table border="1"> <tr><td>PLASTIC WRENCH</td></tr> <tr><td></td></tr> <tr><td>1 PC</td></tr> </table>	PLASTIC WRENCH		1 PC					
TOOLS														
5 mm														
2PCS														
PLASTIC WRENCH														
1 PC														

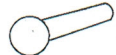
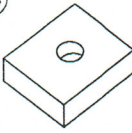
NOTE: There are 8 sets of Bearings (#8 & #9) have already been attached on the Table Body(#1).

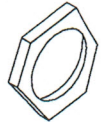
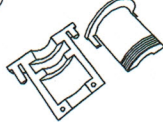
ADDITIONAL AND PRE-INSTALLED PARTS. (FOR REFERENCE ONLY.)

	<table border="1"> <tr><td>ROLL PIN</td></tr> <tr><td>4.2*28mm</td></tr> <tr><td>8pcs</td></tr> </table>	ROLL PIN	4.2*28mm	8pcs		<table border="1"> <tr><td>PLAYER</td></tr> <tr><td>115*35mm</td></tr> <tr><td>2 PCS</td></tr> </table>	PLAYER	115*35mm	2 PCS		<table border="1"> <tr><td>ROLL PIN PUNCH</td></tr> <tr><td>4*50mm</td></tr> <tr><td>1 PC</td></tr> </table>	ROLL PIN PUNCH	4*50mm	1 PC
ROLL PIN														
4.2*28mm														
8pcs														
PLAYER														
115*35mm														
2 PCS														
ROLL PIN PUNCH														
4*50mm														
1 PC														
	<table border="1"> <tr><td>MATERIAL SAMPLE</td></tr> <tr><td>5*5*3.8cm</td></tr> <tr><td>1 PC</td></tr> </table>	MATERIAL SAMPLE	5*5*3.8cm	1 PC		<table border="1"> <tr><td>LUBRICANT</td></tr> <tr><td>50ml</td></tr> <tr><td>1 PC</td></tr> </table>	LUBRICANT	50ml	1 PC		<table border="1"> <tr><td>BOLTS</td></tr> <tr><td>M8*85mm</td></tr> <tr><td>2 PCS</td></tr> </table>	BOLTS	M8*85mm	2 PCS
MATERIAL SAMPLE														
5*5*3.8cm														
1 PC														
LUBRICANT														
50ml														
1 PC														
BOLTS														
M8*85mm														
2 PCS														
	<table border="1"> <tr><td>ASSEMBLED TO ②②</td></tr> <tr><td>57*6mm</td></tr> <tr><td>2 PCS</td></tr> </table>	ASSEMBLED TO ②②	57*6mm	2 PCS		<table border="1"> <tr><td>BEARINGS</td></tr> <tr><td>∅57*48.5mm</td></tr> <tr><td>2 PCS</td></tr> </table>	BEARINGS	∅57*48.5mm	2 PCS		<table border="1"> <tr><td>BUMPERS</td></tr> <tr><td>∅16mm</td></tr> <tr><td>2PCS</td></tr> </table>	BUMPERS	∅16mm	2PCS
ASSEMBLED TO ②②														
57*6mm														
2 PCS														
BEARINGS														
∅57*48.5mm														
2 PCS														
BUMPERS														
∅16mm														
2PCS														
	<table border="1"> <tr><td>SOCCER BALLS</td></tr> <tr><td>∅36mm</td></tr> <tr><td>8 PCS</td></tr> </table>	SOCCER BALLS	∅36mm	8 PCS										
SOCCER BALLS														
∅36mm														
8 PCS														

ASSEMBLY INSTRUCTIONS

We recommend that four adults work together to assemble this table.

- Start assembly with the table face down. We recommend placing the table on the soft packaging to protect the table surfaces. After assembling the legs, the table will be flipped over to complete the assembly. Do not use the legs for leverage when rotating the table from the face down to the face up position.

FIG. 1

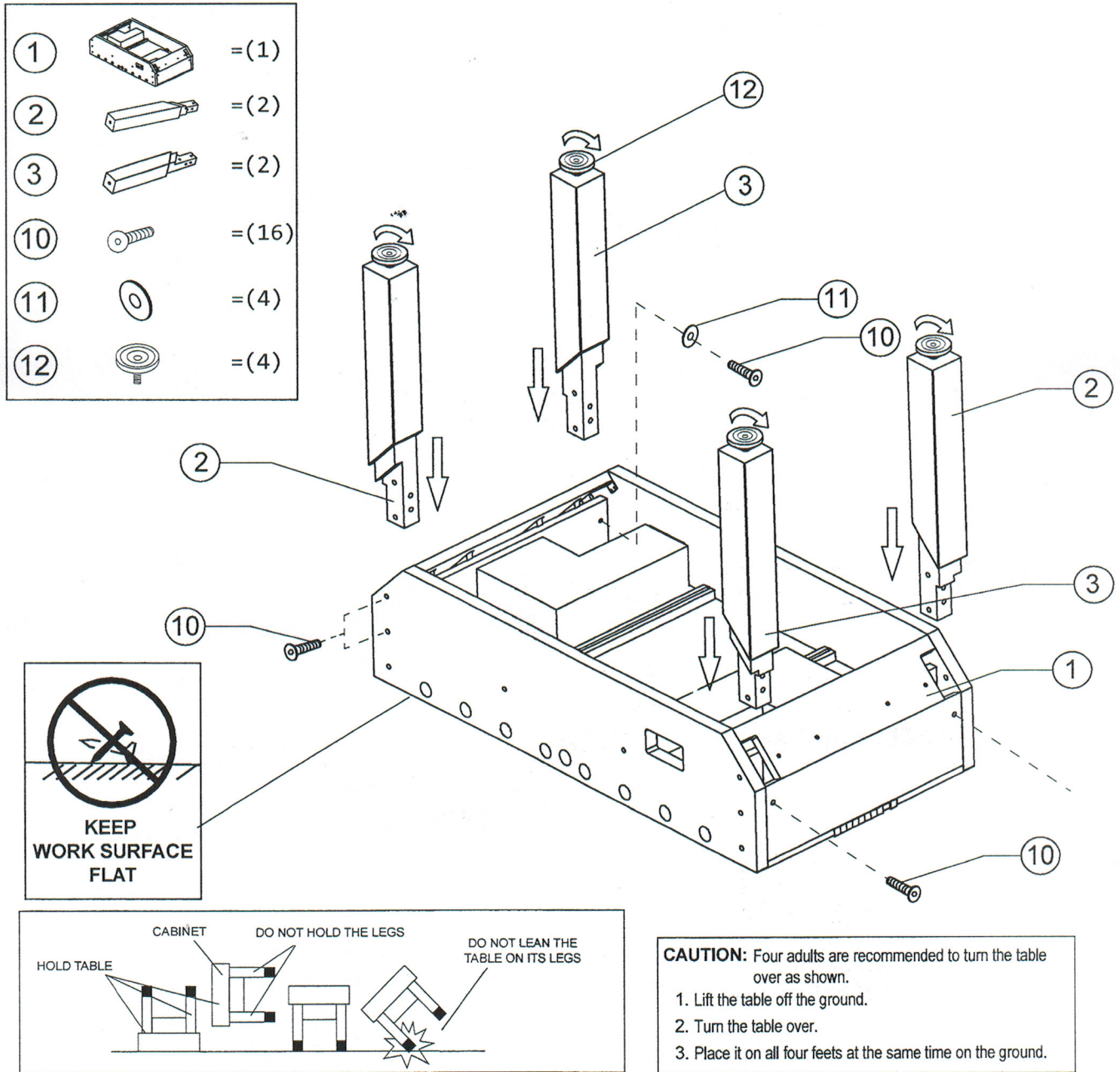







FIG. 1: LEG ASSEMBLY

- Attach the Legs (#2 & #3) between the Side and End Aprons with four Bolts (#10) per Leg as shown in Fig.1. Use the Allen Key (#13) provided.

NOTE: Please lightly tighten each of the four leg bolts equally before finally tightening each bolt securely.

- Insert the Leg Levelers (#12) into the bottom of the Legs (#2 & #3) . See Fig.1.
- Once legs are securely fastened with the leg levelers installed, use four adults to rotate the table into an upright position.

FIG. 2

④		=(2)	⑦		=(2)
⑤		=(2)	⑧		=(16)
⑥		=(2)	⑨		=(16)

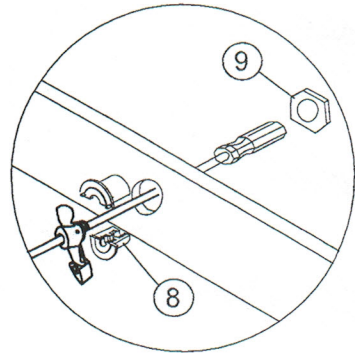
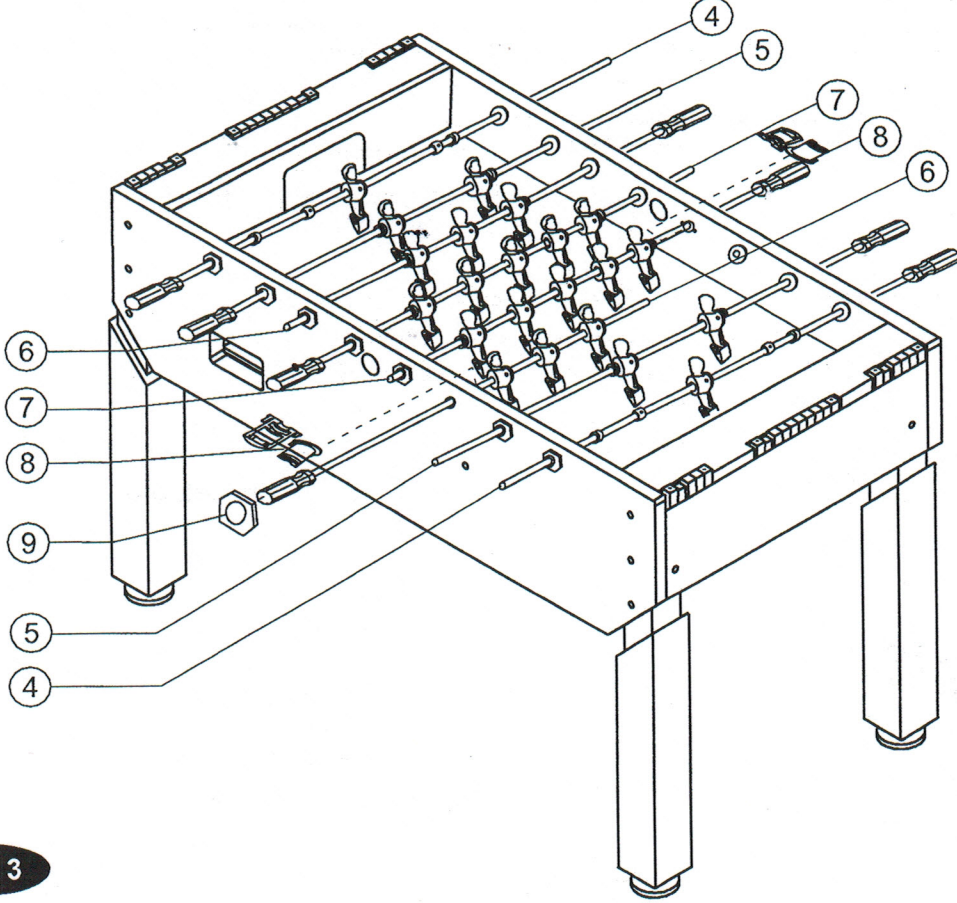

ORDER OF PLAYERS

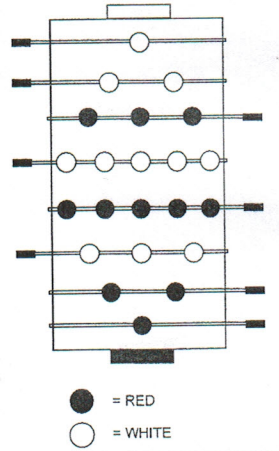

IMPORTANT!
EACH TEAM SHOULD BE HEAD UP AND FACING THEIR OWN GOAL

FIG. 3

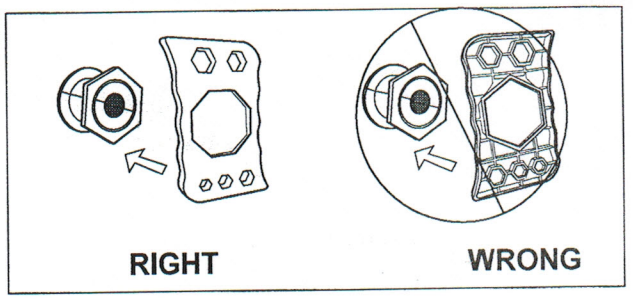
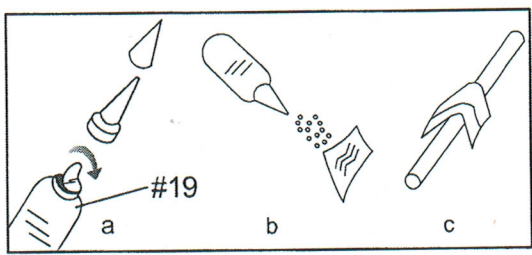

FIG. 2: PLAYER / BEARING / SCORER ASSEMBLY

- Carefully slide the grip end of player rod #6 through the inside of the side apron in the position shown in figure 2 untill the players reach the apron wall. Then slide the other end of the rod through the opening in the opposing apron wall.
- Slide the Player Rods(#4-#7) through the Side Apron in the order shown. See Fig 2.
- Attach all of the bearings(#8) to the side aprons as shown in figure 2.
- Remove the Aluminium foil from top of the bottle, then cut a hole in the end. Spray the lubricant into a clean, soft cloth and then use the cloth to wipe the player rods where they come into contact with the bearings. See Fig 3.

TABLE MAINTENANCE	
TABLE SURFACE	Keep your table covered. If there is dust on the playfield or the aprons, use a vacuum or wipe with a clean, soft cloth to remove. Do not sit on the table and do not use the table outside.
RODS	Occasionally wipe the rods with a clean, soft cloth. Never lift the table by the rods. Do not spin or press the rods too aggressively, as this may cause damage. We recommend the use of lubricant to wipe the Player Rods and Bearings from the outside of the game so as not to drip onto the playfield:
LEGS	Check that the leg bolts are tight. When moving the table, lift table off of its legs and place it down squarely on the legs, do not drag the table.
BOLTS	Please make sure that all the bolts are tightened before using.
METHOD	The table can't be hit by external force or used rough.

FIG.4

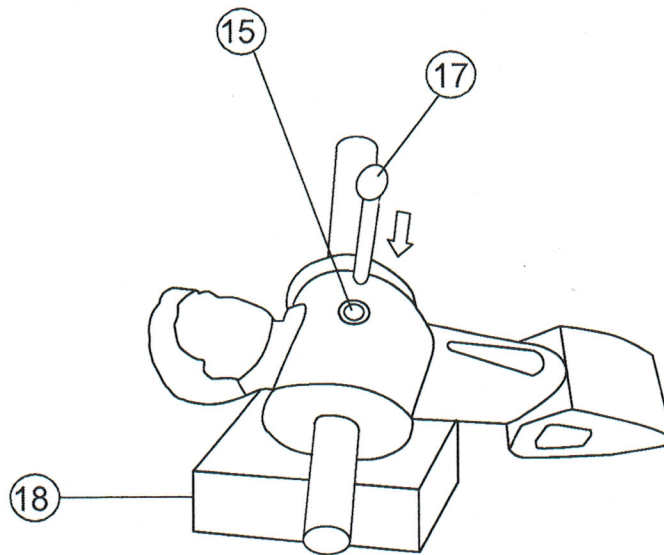
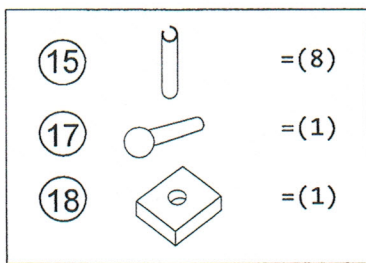

FIG. 4: PLAYER MAINTENANCE

- To remove a player, first remove the rod from the table. After the rod is out of the table, use the pin punch (#17) to remove the pin from the player. Remove the player and then install the replacement player and reinsert the pin (#15) using the punch (#17).

Basic Foosball Rules

Flip A Coin - A coin flip decides who serves the foosball to start the foosball game. After the first goal is scored, the rule is that the team who was last scored on gets to serve the next ball. This rule keeps the game fair for both opponents. The foosball must be touched by a man before the ball goes into a goal for a legal goal to occur.

No Spinning - A spin is a rule for when the rod completes a 360 degree rotation without touching the ball. This is deemed an illegal move in the rules of foosball.

No Jarring - Jarring is a rule for when a player slams his or her rods against the wall of the foosball table in an attempt to distract or jar the foosball loose from the other player's possession. The rule is that there is no jarring allowed at any point during a game. This is not the same as when a player on the opposite team moves his or her foosball rods back and forth in an attempt to play defense. The key this rule is when a player hits the wall of the table with enough force to jar the ball or distract the opponent. That is why this is a subjective rule that may be called more strict by certain foosball players.

Dead Balls - If a foosball stops in the middle of two opposing team rods, the ball must be picked up and reserved. The serve goes back to the team that was last scored on. If a dead ball occurs on the defensive side of the table behind the defensive 2 bar, the defensive player must move the ball back into playing position. This rule is in place so players don't cause a dead ball on purpose in order to force a reserve.

Out of Play - If a ball comes off the table area or hits a top rail and comes back into the table area, the ball is ruled out of play and must be reserved by the team that was last scored on.

5 Bar Passing - These 5 bar passing rules are a little complex if you have never played tournament foosball. These passing rules do not apply to the other foosball rods, just the 5 bar. You are required to pass the ball within a 10 second time period from your 5 bar rod to the 3 bar rod directly after a serve. After the initial serve, you then are allowed 15 seconds to pass from the 5 bar. A ball cannot be completely stopped on the 5 bar and passed forward to the 3 bar, it must be moving and touch 2 men on the 5 bar before being advanced. Additionally, the ball can only touch the wall a total of 2 times in a row (before touching a man again on the 5 bar) before being advanced. However, it can touch the ball a 3rd time if it is part of the pass.